

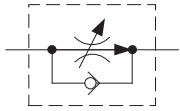

Symbol

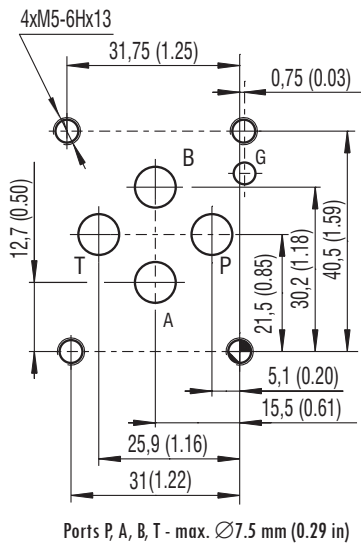

ISO 4401-03-02-0-05



Ports P, A, B, T - max. \varnothing 7.5 mm (0.29 in)

Technical Features

- › Mounting interface acc. to ISO 4401, DIN 24340 (CETOP 03) for use in vertical stacking assemblies
- › Set flow rate independent of load pressure and temperature changes
- › Meter-in, meter-out or bleed-off flow control
- › Integrated reverse flow check valve
- › Adjusted flow rate depends on the orifice area and adjusted differential pressure
- › Wide range of flow rate options
- › Quiet and modulated response to load changes
- › Adjustable by metallic hand screw
- › Fine low-torque adjustment
- › In the standard version, the sandwich plate of valve is phosphated for basic surface corrosion protection and as preparation for painting. Steel parts are zinc-coated for corrosion protection 240 h in NSS acc. to ISO 9227.
- › Enhanced surface protection for mobile applications is available. The sandwich plate and steel parts are zinc-coated with corrosion protection 520 h in NSS

Functional Description

Pressure compensated flow control valves are designed to provide adjustable controlled flow rates independently of changes in inlet and/or outlet pressure. 2-Way valves are used in meter-in, meter-out or bleed-off applications or in parallel arrangement.

The flow control valve consists of a housing, a throttling spool, an internal spring, the pressure compensator and a hand screw for adjustment.

Flow control valve VSS1-206-A

Provides regulated flow from the pump inlet to the consumer. Version A* is delivered without reverse free flow check valve. The version is available as a vertical stack close-off valve or as a sandwich plate.

Flow control valve VSS1-206-B

This valve functions on the same principle as the previous one, however, reverse free flow from port A2 to port A1 is provided by the built-in check valve.

Flow control valve VSS1-206-C

This valve functions as the valve described above, the only difference being the changed flow direction. The flow is controlled in the direction of A2 to A1 and free flow in the direction A1 to A2.

Technical Data

Valve size		06 (D03)		
Max. flow	l/min (GPM)	22 (5.8)		
Max. operating pressure	bar (PSI)	320 (4640)		
Nominal flow rates	l/min (GPM)	6.3 (1.7)	12 (3.2)	22 (5.8)
Min. flow rates	cm ³ (inch ³)/min	60 (3.7)		
Fluid temperature range (NBR)	°C (°F)	-30 ... +100 (-22 ... +212)		
Fluid temperature range (FPM)	°C (°F)	-20 ... +120 (-4 ... +248)		
Maximum degree of fluid contamination	for $Q \leq (1 \text{ l/min})$ for $Q > (1 \text{ l/min})$	Class 20/17/14 according to ISO 4406 Class 21/18/15 according to ISO 4406		
Max. flow rate variation at pressure change (for $Q > 2.5 Q_{min}$ and $p = 6...100\% p_{max}$)	%	± 5		
Weight	kg (lbs)	0.8 (1.76)		
	Datasheet	Type		
General information	GI_0060	Products and operating conditions		
Mounting interface	SMT_0019	ISO 4401-03-02-0-05 DIN 2430 (CETOP 03)		
Spare parts	SP_8010			

Dimensions in millimeters (inches)

Model A-02

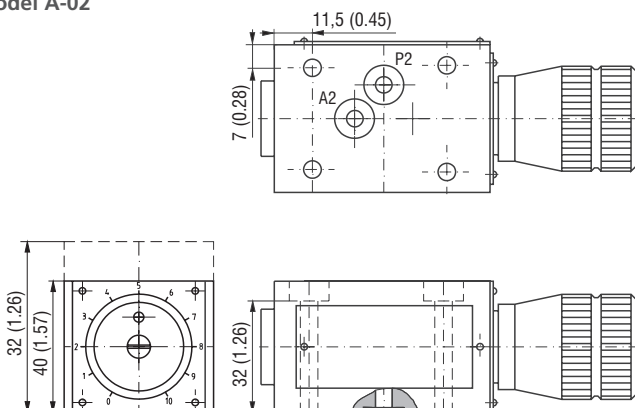

Models A-11
B-11
C-11

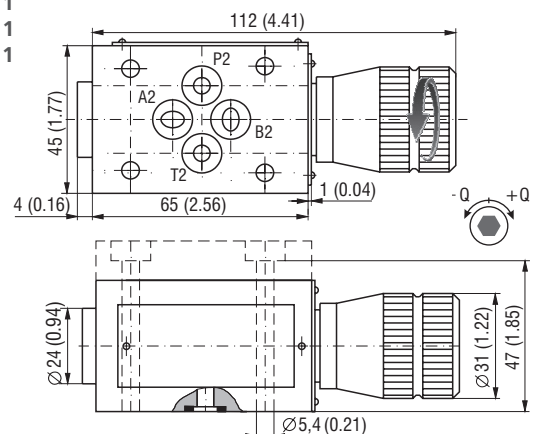

Characteristics measured at $v = 32 \text{ mm}^2/\text{s}$ (156 SUS)

Regulated flow related to input pressure

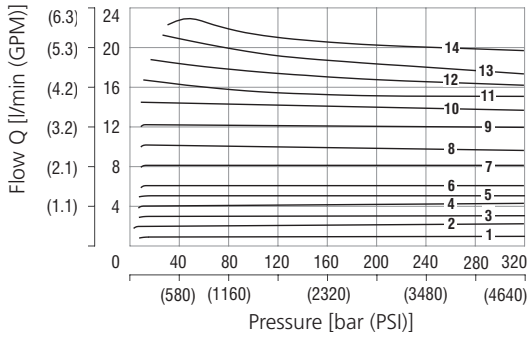

Flow direction - see Functional symbols

No.	Flow rate
1	6.3
2	6.3 12 22
3	6.3
4	6.3 12 22
5	6.3
6	6.3 12 22
7	12 22
8	12 22
9	12 22
10	22
11	22
12	22
13	22
14	22

Flow rate related to indicated scale

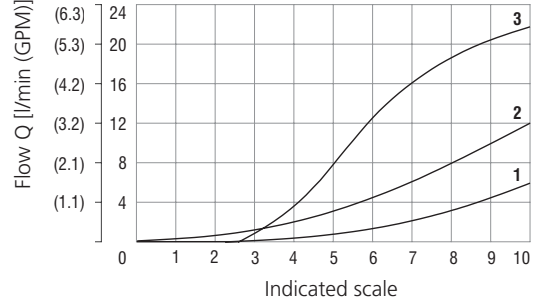

No.	Model	
1	VSS1-206-6.3x-xx	Flow control P → A
2	VSS1-206-12x-xx	
3	VSS1-206-22x-xx	

Pressure drop related to flow rate

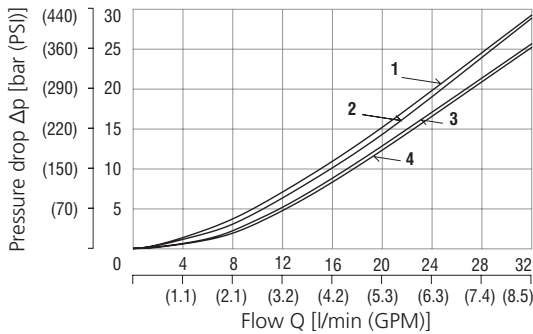

Flow direction see Functional symbols

No.	Flow rate	
1		Flow orifice closed
2	6.3	Flow orifice open
3	12	
4	22	

Functional Symbols

Model

A-02

A - without check valve

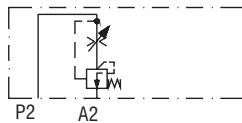

A-11

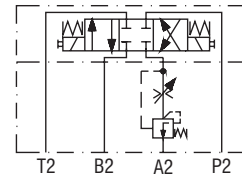
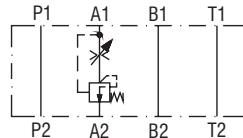

Typical application of the valve in a stacking assembly*

B - with check valve, meter-in mode

B-11

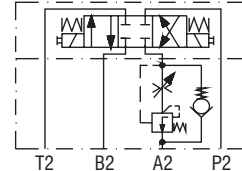
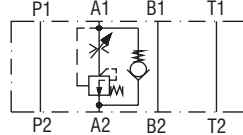

C - with check valve, meter-out mode

C-11

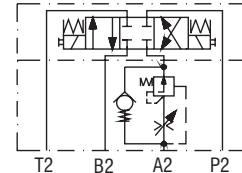
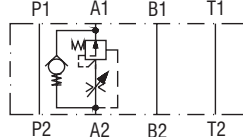

*Directional valve must be ordered separately.

Ordering Code

VSS1-2 06 - [] [] RS [] - []

2-Way flow regulator with reverse flow check, pressure compensated, modular

Valve size

Flow rate

6.3 l/min (1.7 GPM)

12 l/min (3.2 GPM)

22 l/min (5.8 GPM)

6.3

12

22

Model

subplate mounted - without check valve

sandwich plate - without check valve

sandwich plate - with check valve, meter-in mode

sandwich plate - with check valve, meter-out mode

A-02

A-11

B-11

C-11

No designation

body phosphated, steel parts

zinc-coated (ZnCr-3), ISO 9227 (240 h)

A zinc-coated (ZnCr-3), ISO 9227 (240 h)

B zinc-coated (ZnNi), ISO 9227 (520 h)

Surface treatment

No designation

V

Seals

NBR

FPM (Viton)

Adjustment option

hand screw, metal